

Quick Start Reference Guide

Refer to Product Safety Manual for Safety Statements

Complete Owner's Manual available online

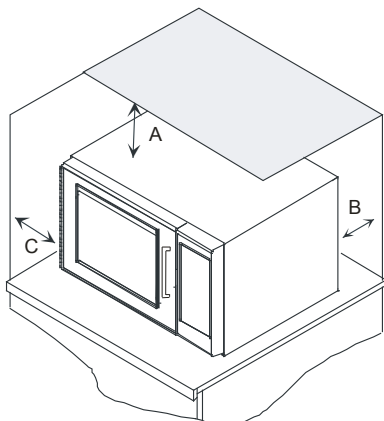



Oven Wall Clearances

- A—Allow at least 2" (5.1 cm) of clearance around top of oven. Proper air flow around oven cools electrical components. With restricted air flow, oven may not operate properly and life of electrical parts is reduced.
- B—There is not an installation clearance requirement for the back of the oven.
- C—Allow at least 1" (2.54 cm) of clearance around sides of oven.
- D—Install combination oven so oven bottom is at least 3 feet (91.5 cm) above floor.





So...how do I use it? *(Electronic Control)*

Manual Operation

To cook food using a specific entered time and power level:

1. Open oven door and place food in oven. Close door.
2. Press TIME ENTRY  pad and enter cooking time.
3. Press a power level pad to change power level if desired (some models).
 - **COOK LEVEL** displays with the power setting.
4. If stage cooking is desired, press TIME ENTRY  pad and repeat steps 2 through 4.
5. Press START  pad.
6. At end of cooking cycle oven beeps and shuts off.

Programming Items

1. Open oven door.
2. Press and hold pad 1 for approximately 5 seconds.
3. Press pad to be reprogrammed.
4. Enter cooking time by using the number pads.
5. Press a power level  pad to change power level if desired.
6. If stage cooking is desired, press TIME ENTRY  pad.
 - Display briefly shows the stage number.
 - Display changes to cook time and power level for the next stage.
7. Enter cook time and power level as in steps 4 and 5 (some models).
 - To enter another cooking stage for that pad, press TIME ENTRY  pad again.
 - Up to four different stages can be programmed (some models).
8. Press START  pad to set new programming changes to the pad.

NOTE: To discard changes, press STOP/RESET  pad or close oven door.

X2 Pad

1. Open oven door and place food in oven. Close door.
2. Press X2 pad.
3. Press desired preprogrammed pad or pad sequence.
4. Oven begins cooking. Displayed cooking time is the total of original cooking time and added X2 time.

6 Preprogrammed Pads

To cook food using preprogrammed cooking sequences:

1. Open oven door and place food in oven. Close door.
2. Press desired pad.
3. Oven begins to cook.
4. At end of cooking cycle oven beeps and shuts off.

X2 Programming

To change the cooking factor:

1. Open oven door.
2. Press and hold pad 1 for approximately 5 seconds.
3. Press pad to be reprogrammed.
4. Press the X2 pad.
5. Press a numbered pad to change the cooking factor.
 - Cooking factor can be set from 10% to 100%.
 - Default is 80%.
 - Pad 5 would change the cooking factor to 50%.
6. Press START  pad to save changes.

The switching operation of this microwave oven can cause voltage fluctuations on the supply line. The operation of this oven under unfavorable voltage supply conditions can have adverse effects. This device is intended for the connection to a power supply system with a maximum permissible system impedance Z_{max} of **0.2 Ohms** at the interface point of the user's supply. The user has to ensure that this device is connected only to a power supply system which fulfills the requirement above. If necessary, the user can ask the public power supply company for the system impedance at the interface point.

Quick Start Reference Guide

Refer to Product Safety Manual for Safety Statements

Complete Owner's Manual available online

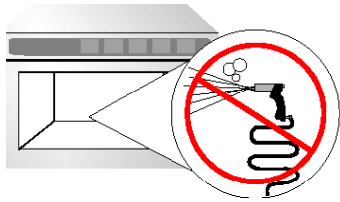

DO NOT power spray

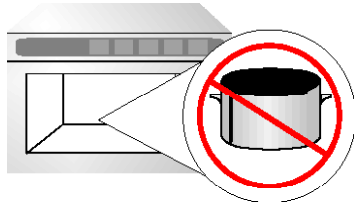



No metal pans

Can I change an option?

Options such as single or double pad programming, beep volume, and maximum cooking time can be changed to suit individual preferences.

To change options:

- Open oven door.
 - If door is closed or STOP/RESET  pad is pressed before programming is complete, changes are discarded and microwave exits programming mode.
- Press and hold pad 2 for approximately 5 seconds.
 - This begins options mode.
 - Microwave will beep and **OP :** displays.
- Press number pad that controls option to be changed.
 - See table below for options.
 - Current option will display.
- Press number pad again to change the option.
 - Each time pad is pressed, option will change.
 - Match code displayed with code for desired option.
- Press START  pad to save changes.
 - To change additional options, repeat steps 3 and 4.
 - Changes appear after door is closed or STOP/RESET  pad is pressed.

| Numbered Pads | Display | Options (Factory Settings in Bold) |
|--|---|--|
| 1 End of Cycle Beep | OP:10 OP:11 OP:12 | 3 second continuous beep Continuous beep until door is opened 5 beep bursts until door is open |
| 2 Key Beep Volume | OP:20 OP:21 OP:22 OP:23 | Eliminates beep Sets volume to low Sets volume to medium Sets volume to high |
| 3 Key Beep | OP:30 OP:31 | Prevents beep when pad is pressed Allows beep when pad is pressed |
| 4 Active Display | OP:40 OP:41 OP:42 OP:43 | 15 seconds after oven door is opened, keyboard disabled 30 seconds after oven door is opened, keyboard disabled 1 minute after oven door is opened, keyboard disabled 2 minutes after oven door is opened, keyboard disabled |
| 5 On-the-Fly Cooking | OP:50 OP:51 | Prevents different pre-programmed pads to be activated during cooking Allows different pre-programmed pads to be activated during cooking |
| 6 Reset to Ready Mode | OP:60 OP:61 | Opening oven door does not reset oven back to ready mode Opening oven door resets oven back to ready mode |
| 7 (some models) Maximum Heating Time | OP:70 OP:71 | Allows 60 minutes of heating time Allows 10 minutes of heating time |
| 8 Manual Operation | OP:80 OP:81 | Allows use of preprogrammed pads only Allows use of manual time entry and preprogrammed pads |
| 9 Double Digit Operation | OP:90 OP:91 | Allows 10 (0-9) preprogrammd pads Allows 100 (00-99) preprogrammed pads |
| 0 Clean Filter Message | OP:00 OP:01 OP:02 OP:03 | Do not display message Display message for 24 hours every 7 days Display message for 24 hours every 30 days Display message for 24 hours every 90 days |